



an EnPro Industries company

Proven Solutions for the Global Compression Industry™

MECHANICAL PACKING **Design and Theory of Operation**



Mechanical Packing

Design and Theory of Operation

One of the vital parts of any machine in which gases are compressed or expanded is the seal around the reciprocating rod, through which power is put into or taken from the cylinder. This seal is called packing. The word packing comes from the method of sealing in pressure where the stuffing box around a pump or compressor shaft is "packed" with a soft material. The type of seal we will discuss is a mechanical seal, which is often also called by the following names:

- Metallic Packing - from the earliest days when the parts were all metallic.
- Floating Packing - because the sealing rings are free to move.
- Segmental Packing - from the segmented construction of the rings.
- Mechanical Packing - since it is a precision machined part which functions on principles of mechanics.

Mechanical packing is made of many materials and sizes, depending upon the specific application involved, and may be utilized to seal pressures ranging from a vacuum to pressures currently as high as 50,000 psi, with sealing rings of all the bearing metals and many plastics. The variables of type of gas, suction and discharge pressures, temperature, speed and length of stroke, lubrication, rod material, and

dimensional limitations must be taken into account. A set of packing may vary in cost from a few dollars to several thousand, depending on construction and material. It is one of the most critical parts involved in the operation of a compressor. Failure of the packing to operate satisfactorily can prove to be very expensive in terms of plant downtime and loss of output.



Purpose of Packing

The purpose of packing is to prevent leakage of a gas between a cylinder and a piston rod. It is necessary to seal this clearance even when compressing a harmless or inexpensive gas. Take, for example, an air compressor. As the clearance between the rod and the opening increases or decreases, the amount of leakage will increase and decrease as well. The larger the passage for the gas to escape, the larger the leakage will be. If the machine is operating at a sufficiently high speed and the flow through the discharge valves is rapid, the compressed gas will take the path of least resistance through the valves rather than through the restricted opening between the rod and the cylinder. Compressors have been built without conventional seals based on these principles. They have reduced clearance to a minimum in a bushing around the piston rod and have run the engine at high enough speeds that leakage past the bushing was insignificant in comparison to the flow through the discharge valves. However, creating and maintaining

such a seal is impractical for several reasons. First, the high velocity of the escaping air would cause erosion of the rod and bushing. Second, perfect alignment must be maintained so that the rod and bushing do not come into contact and cause wear and frictional heat. Third, no compensation is made for the difference in fit of the rod and bushing at operating temperatures. Fourth, running at extremely high speeds, in order to avoid extreme leakage, may be impossible because of speed limitations of other parts of the compressor. It is for these four reasons that packing as we know it today is used as standard equipment as a seal on reciprocating compressors. To be considered successful, it is necessary that this packing prevent the leakage of gas through the clearance between the cylinder head and the piston rod. The packing must operate over a long period of time with little or no leakage, and a minimum of friction and resultant wear while compensating for wear, lateral movement of the rod and changes in temperature.

Packing History

Sealing of the piston rod was originally accomplished on the first steam engines by cutting washers from ham rind to fit the piston rod and placing them around the rod where it entered the cylinder in the recess known as the stuffing box. Pressure was then applied to them through a bolted flange and follower, the follower having a tapered face which caused the washers to press on the rod and make the seal. The natural grease in the ham rind gave good lubrication as did the packing, but required a maximum amount of maintenance and constant adjustment. As steam temperatures and pressures increased, greater demands were put on the packing. For this reason, more high-tech materials were

sought. Operators then tried various forms of fabric packing, usually lubricated with flake graphite and oil. These performed with varying degrees of success but rapidly lost ground, and soon the early forms of metallic packing began to appear. These took the form of wedge-shaped pieces of some soft metal arranged so that pressure from the flange caused them to press onto the piston rod. Like their predecessors, they required continual maintenance, consumed much of the engine's power and scored the piston rods rapidly.

Full Floating Principle

Around the close of the 19th century, packings of the full floating metallic type were first marketed. The "floating" principle means sealing elements of the packing are free to move within the assembly as opposed to non-floating packings in which the sealing elements are held rigidly in the stuffing box and require outside adjustment to compensate for wear or misalignment. The full floating metallic packing was designed to:

- Take advantage of the operating economies resulting from the elimination of friction-producing materials such as hemp, duck, rubber, metal foil, metal shreds and innumerable combinations of these materials previously used as packing materials.
- To utilize a precision machined, anti-friction metal sealing ring that will withstand high temperatures and pressures.
- To provide an effective seal on piston rods that rise and fall or have a lateral movement as they move through the packing due to wear of the crosshead or cylinder, unequal expansion of the parts, misalignment, or innumerable causes which can create such a condition.

These built-in features made this type of packing desirable for all reciprocating engines and compressors and a must for machines

operating at high pressures and elevated temperatures. But the term "metallic" packing is, at least partially, a misnomer. Originally it was termed metallic packing because all of the parts were made from metal, primarily cast iron. As pressure conditions and temperatures increased, various grades of bronze were used for the wearing parts and, as other gases were becoming more common in the chemical industry, various plastics and non-metallics were added. The term then evolved into "mechanical" packing, which is the seal as we know it today. Its parts are rigid and interwork mechanically to reduce the clearance around the piston rod to the point where leakage will not occur. Unlike soft packing which requires continual external adjustment, it is self-adjusting, and compensates for wear and temperature changes.

A. Packing Set

The packing unit is made up basically of two parts: the packing case (See Fig. 1) and the packing rings (See Fig.2). The case is a series of retainers gasketed on the surface of the contact of the cylinder, centered around the piston rod by a stuffing box and held in place by a flange bolted to the end of the cylinder. The number of retainers and consequently the number of sealing elements is determined by the operating conditions of the compressor, and by standards established by the individual packing manufacturers for the various conditions. These will vary in number from two or three retainers for pressures up

to 200 psi to seven or eight for the highest pressures in the industrial reciprocating compressors. Until a few years ago, packings with 12 to 15 sealing elements were not uncommon. However, as rotative speed increased and the stroke of the compressor was reduced, it was found that much was to be gained by decreasing the length of the packing necessitating a reduction in the number of sealing elements. This was achieved through the ability of the manufacturer to obtain finer finishes on all the sealing parts on a production basis.

B. Packing Cups

The packing retainers which are referred to as packing cups are machined to provide a nominal amount of clearance around the piston rod so that the rod will not contact them should any lateral movement occur due to run-out, misalignment or wear. This clearance will vary with piston rod diameter, with the operating pressure, and is also influenced by the compressor design and the possibility and magnitude of change in piston rod orientation. As an example: on non-lubricated compressors where the piston is supported on wear rings which may be subject to a high rate of wear causing both the piston and the piston rod to drop from their initially aligned position, increased clearance is generally added between packing cups and the piston rod. Depending on these factors just described the clearance between the packing case and the piston rod may vary from 1/32" to 3/16". The recess which houses the packing rings is held to a fixed depth which allows side clearance

between the cups and the rings. The faces of the packing cups are ground, or ground and lapped, depending on the pressure, and the gas being sealed. Special care is taken to ensure that the faces are both flat and parallel so that when assembled in the stuffing box, and bolted in place, they will present surfaces which are perpendicular to the piston rod. The pressure necessary to ensure a seal between cups and to seat the gasket between the end of the packing and the bottom of the stuffing box is furnished by the flange. It can be seen from Fig.1 that the clearance between the cups and the rings is unaffected by stud pressure, so that the rings will be free to move axially within the cup. It should be noted that the rings contact the case only on the sealing face. They do not in any way support the rod through contact with the packing case.

Fig.1 | Mechanical packing nomenclature

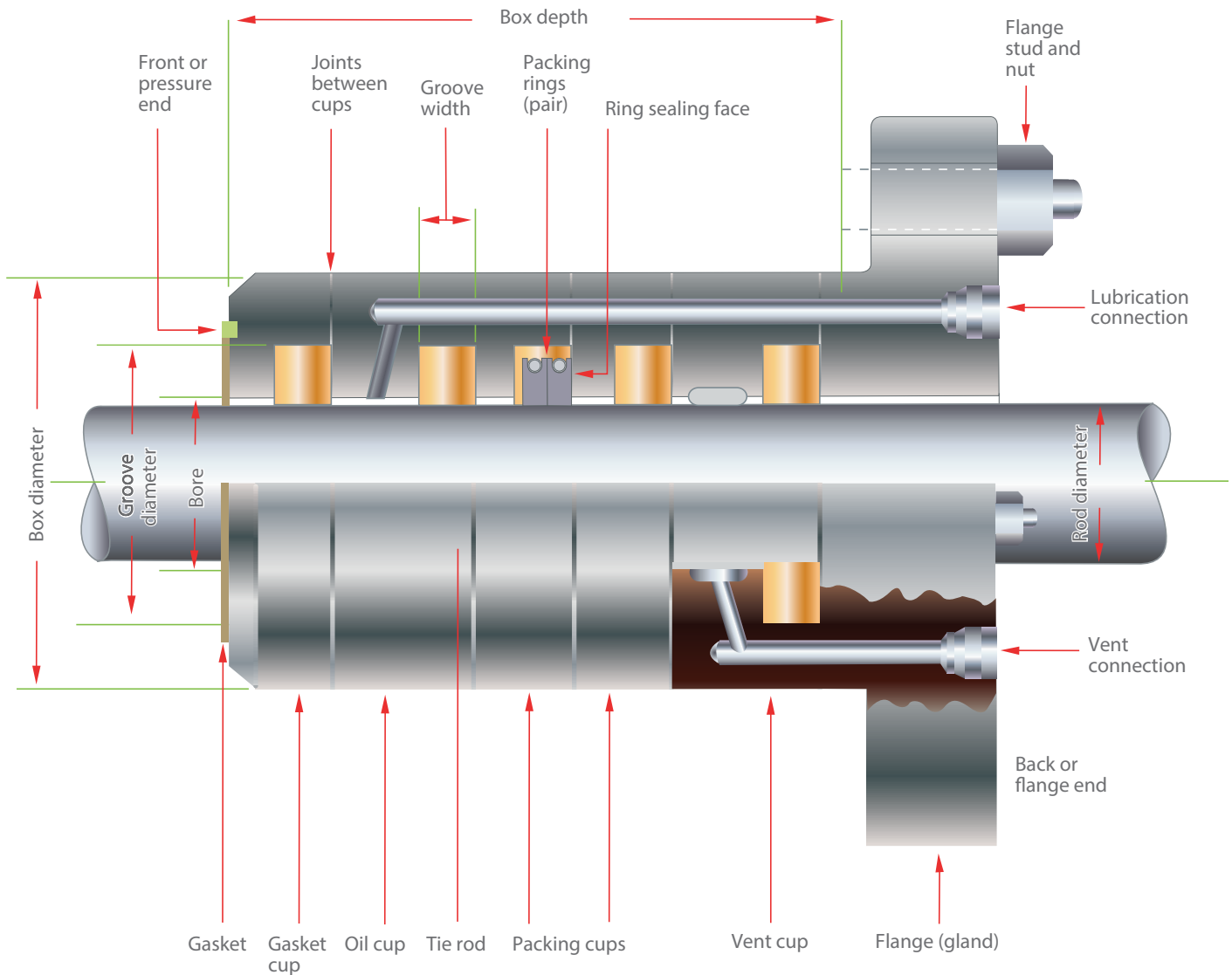
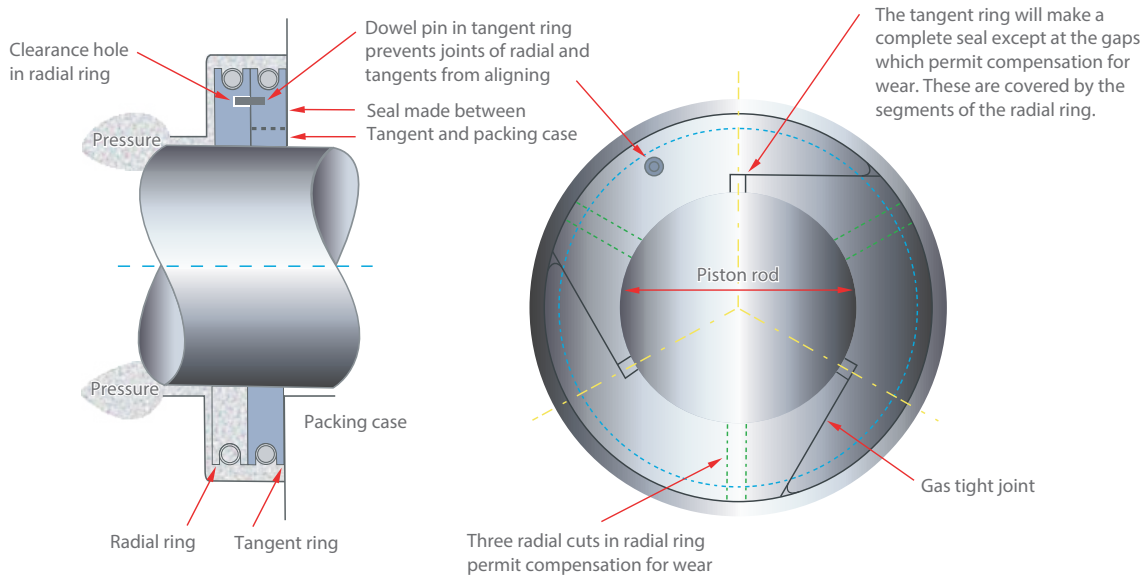

Fig.2 | The basic sealing element of a mechanical packing



Joints Between Cups

The joints between the packing cups may take one of several forms (See Fig.3). They may simply be ground or ground and lapped; they may have a tongue and groove gasketed joint, or they may have a ground joint with an auxiliary "O" ring seal. In the latter type, the "O" ring is in effect "insurance" since the ground joint properly loaded can form a satisfactory seal for all pressures. These various types have their advantages and disadvantages.

The **Ground Joint** is the least expensive to produce and probably is in widest use. It has the disadvantage of being susceptible to damage by scratching or through foreign material getting between the two surfaces. Generally this is a suitable joint for pressures up to the range of 3000 psi. For higher pressures, lapping of the surface is desirable since it removes minute scratches left by grinding which could be a possible source of leakage at higher pressures and even at lower pressures with certain gases, such as hydrogen. Both ground or lapped joints have the advantage of accurate control of side clearance of the packing rings, but each is vulnerable to foreign materials or scratching.

The **Tongue and Groove Gasketed Joint** has the disadvantage of being relatively expensive to manufacture and makes holding of the side clearance on the packing rings more difficult since the crush of the gasket is difficult to predict and it is necessary to maintain three tolerances accurately — the width of the ring groove, the depth of the gasket groove and the thickness of the gasket. Its most serious disadvantage is that uneven tightening of the flange studs can cause cocking of the packing cups, through uneven crushing of the gasket, not keeping them perpendicular to the piston rod. The advantage of this type of joint is that it is the least susceptible to damage and even small scratches in the metallic part of the joint can be sealed through the soft gasket. The seal between the cups can be renewed simply by replacing the gasket without the necessity of resurfacing the sealing faces.

Fig.3 | Typical methods of sealing between cups

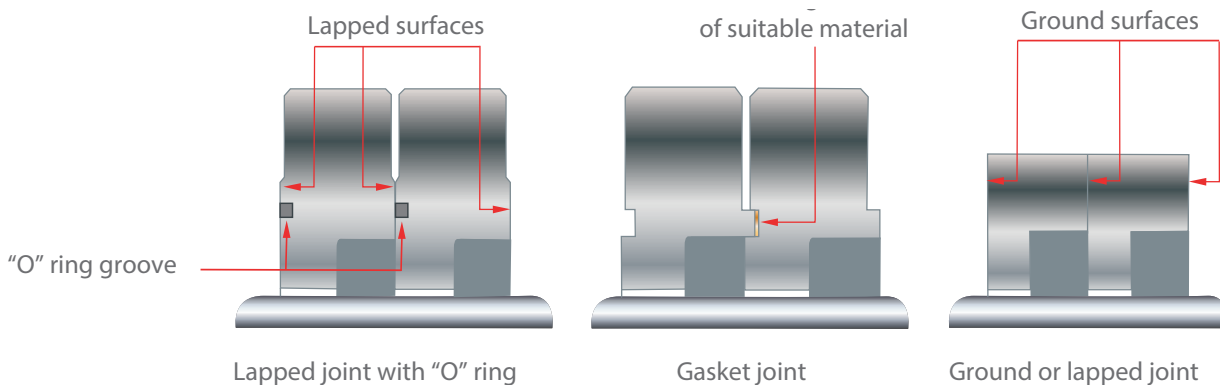

Fig.4 | Methods of introducing lubricants



Ground Joint with "O" Ring Seal is one of the latest and relatively inexpensive developments in seals between packing retainers. The joint itself may be ground or ground and lapped, dependent upon pressures and the gas being handled. It has the advantage of the tongue and groove joint in that it will compensate for some minor injury to the joint, and the advantage of the ground joint, in that it is possible to control accurately the side clearance of the packing rings.

Lubrication Connections

Lubrication connections to a packing case generally take one of three forms. These will vary with pressure and physical space limitations or requirements.

The **Ordinary Pipe Thread Type of Connection** is made on packings for lower pressures. It may take one of several forms. Where it is possible, the packing set is drilled with an oil passage to introduce lubrication at the desired point and the oil connection is made on the face of the packing flange. In some instances the pipe thread connection is made directly into the packing cup. The first of these methods is shown in Fig.1. The latter is shown in Fig.4.

Gasketed Oil Tube Connections are desirable as pressures increase. With these, the connection is made directly to the cup through which oil is being fed (See Fig.4). The oil tube may be threaded directly into the cup or may be "jacked" against the outside of the cup through a flange

arrangement on the outside of the cylinder. In either case, completely confined gaskets are used to make the seal between the packing cup and the end of the oil tube.

The **59°-60° Joint** is used on very high pressure packings. With this type of joint the seat in the packing cup is accurately made at 60° and the end of the oil tube is accurately made at a 59° angle, so that contact between the two will give a line contact and make a very good seal. Because this particular type of joint requires more maintenance than the others, it is generally used only on very high pressure packing where the sealing is critical. See Fig.4.

Vent Connections

The vent connections to the packing set may be made in much the same manner as the oil connections. Generally, because they are low pressure, they use ordinary pipe thread fittings. Example shown in Fig.1.

Fig.5 | Geometry of the tangent joint packing ring

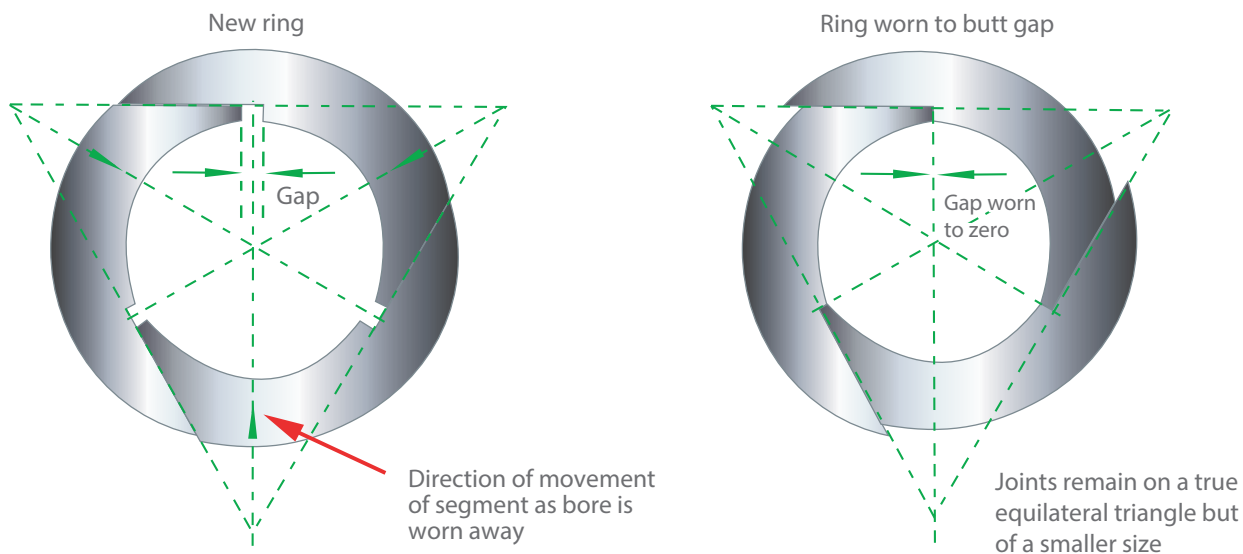
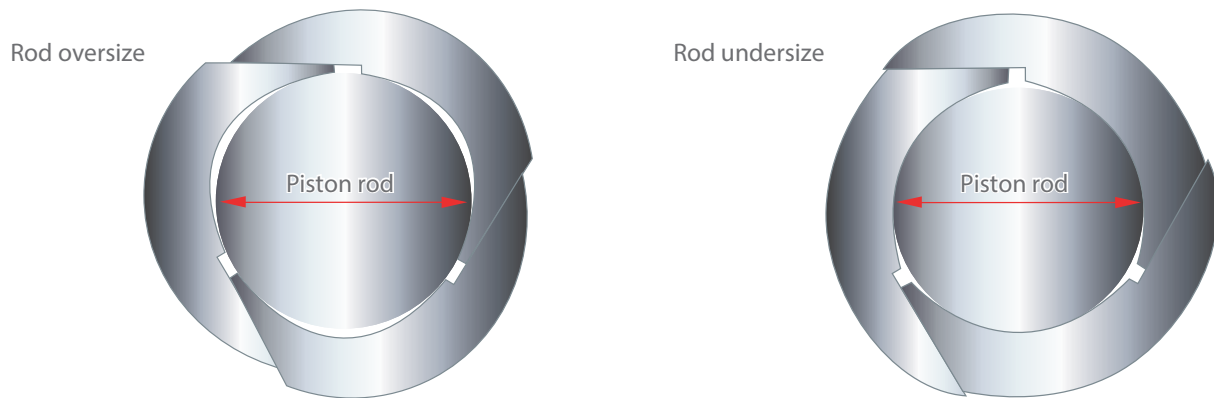

Fig.6 | How a standard bore packing ring will fit an oversize and an undersize rod. Note: joints remain in contact



C. Packing Rings

The packing rings are the other component of the packing unit. These are actually the heart of the packing and the elements which make the seal, compensate for wear, movement of the rod, and temperature change. There have been many patents obtained on various types of packing rings; however, the most popular and widely used design is that patented by A. W. France, November 7, 1899.

Fig.7 | Surfaces on which leakage can occur are moving surfaces and require an oil film to minimize wear. Arrows indicate possible paths of leakage.

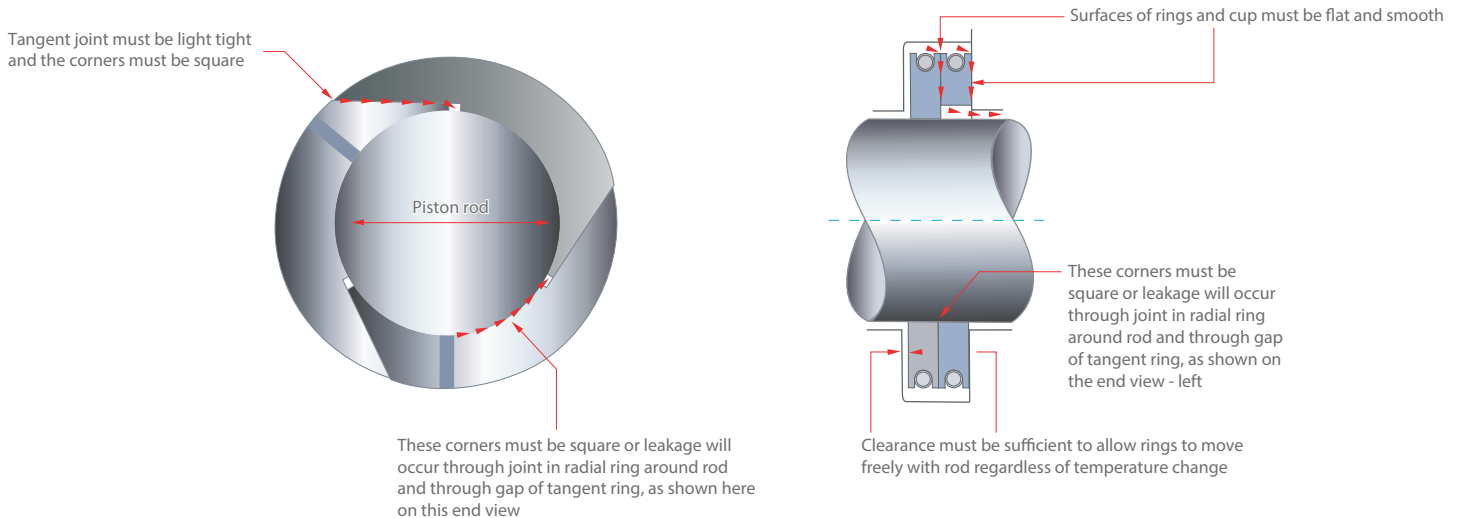

Segmental Packing Ring Operation

The principle of this packing (See Fig.5) is that the three cuts of the tangential ring lie on the sides of an equilateral triangle. This ring is so cut that the segments maintain contact at the joints with variations of the inside diameter of the ring (See Fig.6). As wear occurs on the bore of the ring or on the rod, the ring will collapse, with the segments moving in the directions indicated by the arrows in Fig.5, and will continue to make a seal both on the bore and on the tangential joints. Obviously this ring cannot by itself create a seal since the gaps provided to permit the ring to collapse as it wears leave a straight path for leakage. To seal these gaps another ring is cut into three segments with simple radial cuts and paired with the tangential ring. Each segment overlaps and

seals the gaps in the tangential ring (See Fig.7). The radial ring can also compensate for wear on its bore simply by closing its radial joints as wear occurs. A dowel pin in the tangential ring prevents rotation of one ring with respect to the other, and prevents alignment of their joints. This combination of two rings doweled together is commonly referred to as a pair of rings but is a single sealing element. These two rings together make a seal along the piston rod. To prevent gas from bypassing the rings, the tangential ring also seals along its back face against the sealing surface of the packing cup immediately behind the one in which it is housed.

The seal then is made by the combination of radial and tangential rings on their bores along the piston rod, between the back of the tangential ring and the sealing surface of the cup and through the tangential joints of the tangential ring. See Figs.8 and 9 for the percentage breakdown of leakage past a pair of rings and the pressure conditions at three locations on the rings.

With the packing rings in place on the piston rod and the tangential ring making contact with the sealing face of the cup, clearance exists

between the side of the retainer or packing cup and the face of the radial ring. Through this clearance and through the end gaps of the radial ring, pressure can build up on the outside of both the radial and tangential rings and can also relieve itself toward the cylinder on the suction stroke of the compressor cycle, provided, of course, that the pressure existing around the rings exceeds the suction pressure of the cylinder.

What Happens When Rings are Reversed?

If you visualize this pair of rings reversed in the grooves so that the radial ring is against the sealing face of the cup, clearance will then exist between the pressure side of the tangent ring and the cup, permitting pressure to build up on the outside of the rings and to bypass the rings through the radial joint of the radial ring. Correctly positioned, the radial ring always faces the highest pressure.

In some instances, where a packing may be subject to a fluctuating pressure differential, such as a machine using a pressurized distance piece or one used between two cylinders where the highest pressure

will fluctuate from one end of the packing to the other, double tangent pairs of rings must be used so that sealing can be accomplished in either direction. Except as dictated by special sealing requirements as just described, generally it is not desirable to use double tangent pairs of rings since with their use it is possible to trap pressure within the packing case and cause more rapid wear than would otherwise exist.

Plastic Materials

The development of plastic materials, particularly the filled TFE materials for both lubricated and non-lubricated service, have brought about some alteration in packing ring configuration as just described. These materials under elevated temperatures and pressures tend to creep and extrude into the clearance between the packing cups and the piston rod. To permit the necessary clearance between the packing cups and the piston rod to exist and at the same time prevent extrusion of the plastic sealing rings, the anti-extrusion or back-up ring was developed.

These rings may be either segmental or uncut and they are bored to have a small amount of clearance on the piston rod. They are designed to "float" with the packing rings without themselves transmitting any load from the gas pressure to the piston rod. The anti-extrusion or

back-up ring may be used with a conventional pair of rings that is one radial and one tangent cut pair or with a single ring which is cut tangent to the piston rod. When a ring cut tangent to the rod is used without a radial ring it becomes a double acting unit similar to the double tangent pair as previously described. Unless the double acting feature is intended, slots are cut across the face of the ring toward the pressure to build up and to relieve pressure on the outside of the ring as previously described.

Fig.8 | Typical test of leakage past a pair of rings showing percentage of total leakage

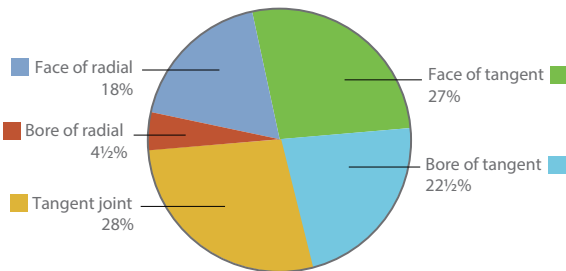
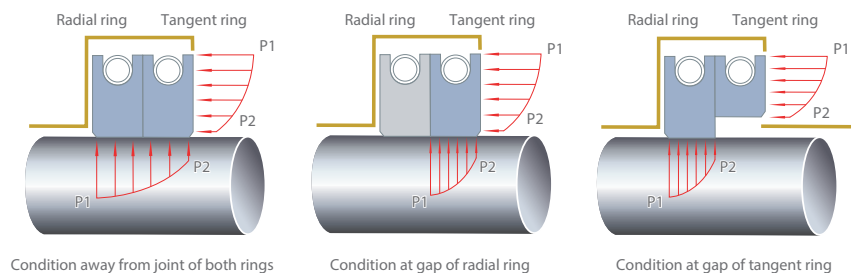

Fig.9 | Pressure drop across a pair of packing rings



Oil Control Rings

Most reciprocating compressors use oil control or wiper rings to prevent crankcase oil from passing into the cylinder and in some instances to prevent condensate, cylinder and packing lubricant from entering the crankcase. On crosshead type machines, this control is achieved through piston rod wiper rings. The desirability and necessity of this control is several fold. First, by containing crankcase oil in the crankcase, the amount of oil entering the cylinder and consequently the gas stream is controlled. Second, the crankcase oil may not be compatible with the cylinder lubricant and may dilute or react with it. Third, oil may not be permissible in contact with the gas being handled — such gases as oxygen and chlorine are examples of these. Fourth, it is desirable to avoid oil contamination of gases intended for “dry” use. Finally, cylinder lubricants and condensate may be detrimental to the bearings and other parts of the running gear if mixed with the crankcase oil.

Fig.10 | Pressure drop pattern through a packing

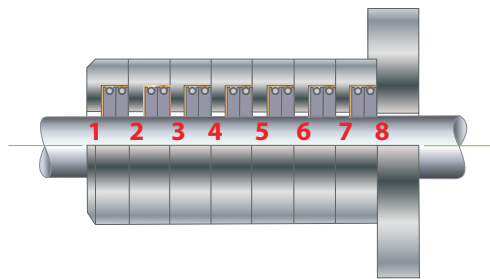

It should be understood that it is virtually impossible to wipe the rod completely dry of oil by mechanical wiper rings. On compressors where crankcase oil must be absolutely excluded from the cylinder and contact with the gas, the compressor must be designed to prevent any part of the piston rod, which enters the crankcase from entering the cylinder.

Segmental wiper rings may be either radially or tangentially cut. They are garter spring actuated. The scraper edges in contact with the piston rod are proportioned to give a bearing load sufficient to break the surface tension of the oil film on the rod and wipe it away. While there are many variations and innovations of wipers, there are basically two types. One is designed to turn back a large volume of oil along the rod. The other type has drainage passages through which oil wiped from the rod drains into an annular area around the outside of the rings and thence back into the crankcase. Normally two or three wipers are used in an oil seal and as previously indicated may be used as a part of or in conjunction with a pressure packing.

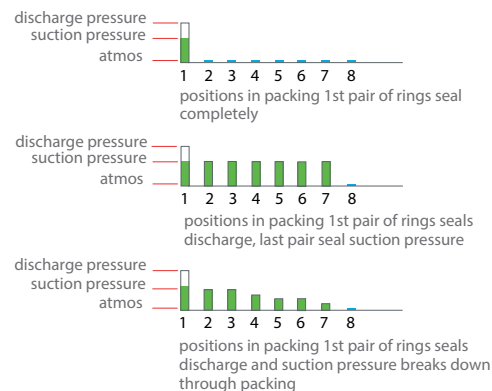

How a Packing Works

As previously described, a packing set consists of a series of sealing units. Mechanical packing is not bottle tight but the amount of leakage is an extremely small fraction of one percent of the capacity of the machine and usually within tolerable limits. If, due to the toxicity of the gas or danger of explosion or corrosion, any leakage exists, it may be vented to a safe place. The fact that the individual rings will leak slightly is the reason for the series of rings. It is through the series of rings that the pressure is broken down from discharge to atmosphere. You will recall that the volume of leakage will increase with an increase in the differential pressure across the rings and will also increase with the time that the differential pressure exists; in other words, the higher the differential pressure and the longer the differential exists, the greater will be the volume of leakage. In normal compressor operation the minimum pressure which will be existent in the cylinder, and consequently to which the packing will be subject, will be equal to the suction pressure. The differential pressure across the packing will fluctuate between suction and discharge pressure on each compression stroke, with the full discharge pressure existing only instantaneously on each stroke. The problem then is one of sealing a minimum of the differential between

suction pressure and atmospheric pressure for a short period of each stroke. These conditions of time and pressure differential give three “normal” patterns of pressure breakdown across a set of packing.

Condition I - Both suction and discharge pressure are sealed by the first pair of rings.

Condition II - The suction pressure is sealed by the last pair of rings and the discharge by the first. Such a condition is believed to be transitory between Condition I and Condition III.

Condition III - This is a breakdown of suction pressure in increments across the rings with each increment reducing the differential and consequently the amount of leakage by any pair of rings. The discharge pressure is generally sealed by the first pair of rings. Should pressure higher than suction exist beyond the first pair of rings, it would on the first suction stroke leak back to the cylinder since the rings will seal in only one direction.

Each of these conditions or patterns (See Fig.10) is considered to be “normal” and will exist alternately during normal operation.

Mechanical Packing for Reciprocating Liquid Pumps

Until recent years the type of packing herein described has been applied only to compressors handling gases. It has been found, however, that by adjusting sealing ring clearances and by making certain modifications to compensate primarily for the incompressibility of liquids that mechanical packing can be successfully applied to reciprocating liquid pumps. The seal in this application requires no external adjustment, produces virtually no plunger wear, and consumes considerably less of the pump's power. Packing case and packing ring materials are the same as those used in compressor packings and their selection is based on compatibility with the liquid being handled, mating material of the plunger, temperature and pressure involved.

Packing Ring Materials

Packing rings have been made from a wide variety of materials, from wood (*lignum vitae*) to sterling silver, and for an equally wide range of conditions. The more common ones, such as cast irons, bronzes, babbitts, laminated phenolics, plastics and carbon graphite materials should be familiar to the maintenance mechanic. He should be familiar with their limitations and uses since much is to be gained by proper selection of packing rings.

Plastics have come into wide use as a packing ring material due to self-lubricating qualities, chemical resistance and a degree of conformability which virtually eliminates the necessity of a break-in or wear-in period. TFE, polyamides, and polyimides filled with a variety of materials to improve their dimensional stability, resistance to cold flow and heat conductivity have become standard materials for both non-lubricated and lubricated service, and are rapidly replacing many materials previously used.

Cast Iron packing rings have a wide range of application on low pressure steam, air, and gases which do not tend to thin lubrication. Generally they are used up to pressures of 600 psi although some manufacturers will surface treat them and recommend their use at slightly higher pressures. They are all dependent on good and sufficient lubrication. Bronze as used in packing rings covers a wide range of alloys.

Bronze rings are used in the highest pressure reciprocating compressor packing made today. Because of their good heat conductivity they will conduct heat away from the rubbing surface, helping to preserve the oil film. Generally, the leaded bronzes have been found most satisfactory and will not scuff or seize on the rod.

Laminated Phenolics also cover a wide variety of materials. They are used where chemical resistance and/or adverse conditions of lubrication are anticipated. Their various grades are particularly recommended for "sour" gases and hydrocarbons in general. They will run with virtually no more than water lubrication, making them a particularly good material

for use on gases which thin lubrication. The material itself is made up of laminations of various woven fabrics impregnated with phenolic resin, bonded by pressure and temperature. The temperature resistance of the material is generally determined by the base fabric. Cotton fabric base materials are limited to 275°F, maximum. Other fabric base materials are limited to 400°F, maximum. For most satisfactory operation they should be used, however, at temperatures less than their maximum limit. Localized surface temperatures may exceed allowable limits and, since the material is a relatively poor conductor of heat, it may be difficult for it to dissipate heat from its rubbing surface. In addition to the variations in base materials, carbon or molybdenum disulfide may be added to the resin to improve the anti-friction properties of the material. Laminated phenolics are generally limited to compressors discharging at less than 1000 psi.

Babbitt rings find most of their use on stainless steel rods where corrosive conditions limit the use of other materials for either packing rings or piston rods. For satisfactory life they should be used only on clean gases, since Babbitt rings are very susceptible to damage and to picking up foreign materials.

Carbon Graphite materials possess self-lubricating qualities and for many years were the only materials suitable for non-lubricated packing. They have high temperature and corrosion resistance to many chemicals and are still used in non-lubricated applications requiring materials with these attributes.

Packing Cup Materials

Packing cup materials are selected for wear resistance, strength, corrosion resistance and heat conductivity. They have been made from a wide range of materials, the most common of which are cast iron, bronze and steel.

Cast Iron has excellent wear resistance and good strength, making it the best selection of materials up to pressures in the neighborhood of 2000 psi, although in some instances it has been used as high as 5000 psi. Its limiting factor insofar as pressure is concerned is the strength of the material.

Bronze, although stronger than ordinary cast iron, has poor wear resistance but superior heat conductivity and in some instances, resistance to chemical attack. For these reasons it is used on many

applications where either exceptional heat conductivity is required or resistance to corrosion and chemical attack is needed.

Steel in several basic forms is used where the stresses induced in high pressure packings require the strength obtainable in steel. Carbon, alloy or stainless steel in the form of either castings, bar or individual forgings may be used. The steels are heat treated to obtain optimum combinations of strength, fatigue resistance and wear resistance.

Lubrication of Mechanical Packing

Lubrication in metallic packing serves a four-fold purpose. It provides a low friction film between the rings, between the rings and the cups, and between the rings and the rod. This film provides resistance to corrosion from moisture and in some cases chemical attack of the gas, it helps in dissipating heat and helps to prevent leakage through minute passages which may exist due to minor damage to the part, such as scratching or slight discrepancies in the fit of the parts due to non-uniform expansion. In these respects the lubrication requirements of metallic packing are much more exacting than those of bearings or other lubricated parts.

The lubricating oil or media used with metallic packing must be able to form and maintain strong films between all of the components and thereby reduce wear and friction since operation of the packing is dependent upon the ability of the parts to move freely under pressure. The rings must be able to maintain sliding contact with the rod, at the same time being free to slide on the cups, compensating for axial movement of the rod.

Generally, lubricant is fed directly to the packing at one or more points from a multiple force feed lubricator. In some instances supplementary

lubrication is obtained from connections in the suction valve chambers, allowing the lubricant to be carried by the gas. Some valve stem packings running on hardened steel rods on steam engines are operated solely with steam-carried lubrication. The same is true of some relatively low pressure compressor packings; however, force feed lubrication is desirable on all lubricated type mechanical packings and is, in fact, a necessity on high pressure packings which use ordinary materials for rings and rod.

Amount of Lubrication

The amount of lubrication fed to a packing will vary substantially with various operations and can be best determined by actual field experience. The use of plastic materials, specifically the filled TFE resins, has made possible successful packing operation with substantially reduced amount of lubrication. In some cases, the use of plastic rings has permitted reduction of 80% in the amount of lubrication which had been fed to metallic rings. While substantial reductions in lubrication are possible with these plastic materials, it should be pointed out

that a lubrication film must be maintained for satisfactory operation. Intermittent lubrication will tend to misplace a film which will be built up on the piston rod surface during periods of dry operation. With any mechanical packing, excessive amounts of oil can be as detrimental as insufficient quantities. This is due to the fact that increased amounts of oxidation products will be formed which tend to be abrasive. In some instances, hydraulic pressure will build up within the packing case and cause excessive wear of the packing rings.

Non-Lubricated Mechanical Packing

Non-lubricated packing, as its name implies, requires no external lubrication. It is made and functions essentially the same as lubricated ones except that the packing ring material is selected for its self-lubricated qualities. These materials have previously been described and include the carbon graphite and the filled TFE resins predominantly. Some materials, such as the phenolic laminates, will run under most adverse conditions of lubrication, even on moisture in the gas, but cannot be considered to be a non-lubricated material in the strictest sense of the word. The most notable difference in lubricated and non-lubricated packings is that cooling of the packing is at much lower pressures due to higher frictional heat and the generally inherent poor conductivity of the packing ring material. As the pressure requirements are increased, it becomes increasingly necessary to remove heat from the packing case, the rings and the rod. With non-lubricated packing, it has been found that even at very low pressures the ultimate life of the packing rings can be extended beyond that normally expected with a non-cooled packing.

It is frequently asked why, if packing can be made to operate without lubrication, are not all packings non-lubricated. This is of course, the ultimate goal of the packing manufacturer and the operator since it would be substantially less expensive from the point of view of lubricant cost and even more of the cost of removing the lubricant from the process gas. Until recent years the answer lay in the life of the packing. Friction and consequently wear were high with the ring materials available and replacement with its costly accompanying downtime were frequent. Today, with the packing ring materials which are available, many operations are converting to the use of minimum lubrication at pressures in excess of 10,000 psi and fully non-lubricated at pressures in excess of 5000 psi. Continuing work in this field indicates that completely non-lubricated compressor packing operation is feasible at even higher pressures.

Temperature Control

The problem of obtaining satisfactory results with packing insofar as temperature is concerned is one of preventing excessively high temperature which would be detrimental to lubrication, either through reducing viscosity or forming of carbon; of limiting as much as possible localized heating of the packing; of keeping the packing temperature as nearly as possible constant; of keeping a temperature from developing in the packing which would be detrimental to the process or the packing ring material; and of maintaining a packing temperature which will not cause moisture or the gas to condense in the cups.

This control is obtained in one or more of the following ways: air cooling, water jacketing the stuffing box, running coolant in direct contact with the packing cups, running coolant through a chamber or series of chambers in the packing, running coolant through a hollow piston rod or running coolant directly in contact with the rod.

The first four of these are based on the assumption that the packing rings will transmit heat from their bore, where it is generated, to the cup, where it is being removed. This assumption does not hold true for all materials. With metallic rings the heat conductivity is such that cooling

the cup can be effective. With non metallic rings, such as laminated phenolics and plastics, because of their poor heat conductivity, the heat must be removed at its source by cooling. This is generally done by cooling by one of the last two methods mentioned. On high pressures (6000 psi upward) and on non-lubricated packing, frequently both cup and rod cooling are used. Each of the methods mentioned has its advantages and disadvantages.

Air Cooling is the simplest and least expensive. It is done simply by allowing the packing to extend beyond the stuffing box and depends on cooling through the transfer of heat to the air circulating around it. It is effective only on packings of low pressure where the requirement of the heat removal is low since air will tend to stagnate in the distance piece around the packing, reducing heat transfer.

Water Jacketed Stuffing Box cooling is provided by extending the cylinder jacket to include the entire stuffing box. This is effective and in most common use. Its only drawback lies in the fact that an air space, although small, helps insulate the packing cups from the stuffing box and requires that the heat be transferred through the cup, the air space and the wall of the stuffing box, to be removed by the jacket coolant. It is because of the distance between the coolant and the source of heat that this method does not give optimum cooling although effective for all but very critical jobs.

Running the Coolant in Contact with the Cups is more effective than the first two methods since it brings the coolant closer to the source of the heat and eliminates the insulating effect of the air space around the packing. It requires that passages be provided on the outside of the cup for flow and that a seal be made around the stuffing box to contain the coolant. Generally, because of corrosion problems, a coolant such as light oil must be used. A system for cooling and circulating the cooling medium is used and consequently, because of the expense involved, this method is limited to critical jobs.

Running Coolant Through the Cups is another method of bringing the coolant in more intimate contact with the source of heat and is generally used on non-lubricated packing where heat transfer must be more rapid. Corrosion-resistant cup materials can be used, permitting the use of water as a coolant, so that a separate circulating and cooling system for the coolant may not be necessary.

Running Coolant Through a Hollow Piston Rod is effective but expensive. It is effective in that it is cooling directly one of the rubbing surfaces generating the heat. Generally, it is used in conjunction with some method of cooling the packing cup.

Running Coolant Directly on the Piston Rod is the most effective method of heat removal although it requires a coolant compatible with the process and frequently requires a separate circulating and cooling system for the coolant.

Regardless of method of temperature control, it must be remembered that the requirement is not to make a packing cold but to control its temperature. Packing temperatures of several hundred degrees on lubricated packing are not unusual nor indicative of trouble. Substantially higher temperatures can be anticipated on non-lubricated packings.

Major Sources of Packing Trouble

There are several indications of trouble with metallic packing that are frequently taken as “the problem” when in reality they are a by-product or a manifestation of the actual source of trouble. Excessive or rapid wear is an example of this. Barring improper selection of mating materials or of material and gas, excessive wear is an indication of one or more of several causes. To fully understand and diagnose abnormal wear, normal wear should be understood.

A. Normal Wear

Wear of sliding parts appears to be inevitable and it is to some extent desirable. It can be broken down into two classes: wearing in and wearing out. We generally consider wearing in to be a burnishing of the rubbing surfaces. With packing, the problem is somewhat different. Packing rings must first undergo a period of wearing out, followed by a period of wearing in, then followed by the normal wearing out. This first wearing out period is caused by the fact that the rings must have a gas-tight fit with the piston rod and must obtain that fit by wearing out to the point of making that contact. Temperatures may vary substantially from front to back of packing and between rod and rings. In addition

B. Causes of Abnormal Wear

Temperature can put the packing back to the high wear rate of the initial wear out-wear in cycle. Radical changes in cylinder or packing temperature can be caused by failure of the cooling system, excessive cylinder temperatures caused by recompression, lubrication failures causing excessive frictional temperatures, and sticking of the rings causing excessive friction.

Lubrication, if thinned beyond the point of effectiveness by the gas or by excessive temperatures, can permit metal contact, giving high frictional temperatures and excessive wear. Build-up of gummy or sticky carbon deposits, due to poor lubrication or reaction with the gas, can cause restriction of free movement of the rings, further contributing to excessive wear.

Blow-By, caused by improper break-in or erosion due to leakage past the bore of the rings after a sudden temperature change, can cause excessive wear or what can be classified as wear.

to the temperature difference, there is the difference of as much as one to two or more times the coefficient of expansion between rod and rings. This means that even though the fit between the rod and the rings is perfect at room temperature, at operating temperature, due to the gradient through the packing and the difference in expansion rates, each pair of rings must wear to a running fit to make a satisfactory seal. Having obtained this fit we should now expect the surfaces to burnish and the original high wear rate to be replaced by a much slower normal wear pattern. What then will change this pattern of normal wear, accelerating it to unacceptable limits?

Moisture, causing pitting, erosion and corrosion, can take place on the rubbing surfaces during shutdown, giving unusual abrasive conditions.

Contamination of the gas with foreign material, such as welding beads, sand, pipe scale, catalyst, etc., will also cause rapid wear through abrasion.

Improper Break-In can be a source of rapid wear if the rings are improperly worn in and a burnished rubbing surface is not obtained. If this condition exists, the rings may continue to wear without obtaining a burnished condition.

Causes of Abnormal Wear of Filled TFE Packing Rings

Because of the wide use of filled TFE plastic as a packing ring material certain peculiarities in its operating characteristics should be understood. While the same conditions which cause abnormal wear in metal packing rings just described apply also to the plastics, there are certain additional phenomena to be considered. To do so, one must understand that because of self-lubricating properties the filled TFE materials will run completely without external lubrication or they will run as any lubricated material except requiring a bare minimum of lubricant. When running without lubricant, the TFE rings will lay down a coating on the mating piston rod surface and once established will

permit the packing rings to run on this film at very low wear rates. When running with lubrication, this film is not established unless the lubricant is completely withdrawn. Once this film has been established, if oil is introduced it will mechanically displace the TFE surface on the piston rod and the rings will operate as lubricated ones. If the lubricant is then withdrawn, the rings will again establish this film on the mating piston rod surface. During this coating period, high wear rates of the packing rings will be experienced. It can be seen that conditions which cause alternate periods of lubrication and non-lubrication to TFE packing rings will be a source of very short ring life.

C. Leakage

It is apparent that wear in itself is not the problem but is a manifestation of one or a combination of problems. Leakage, on the other hand, can be both a by-product and a problem in itself.

Wear can be the most obvious cause of leakage. Complete wearing out of the rings and failure to compensate for additional wear would, of course, permit clearances and leakage. Wear on the sealing face of the cup can prevent proper sealing of the rings against the cup, causing leakage. Wear or damage of the cup may be caused by inadequate or poor lubrication, corrosion, build-up of carbon formations or abrasive material in the gas.

Damage to the Rod in the form of scuffing or scoring can be a source of leakage, or, if excessive wear has occurred on the rod and rings of the original diameter are used, leakage will occur.

Improper Assembly is a readily detectable source of leakage. Rings installed improperly, that is, with the radial ring facing away from the pressure, will allow the packing to leak. If the set has been assembled in such a way that the packing cups are not perpendicular to the rod, the packing rings will not be perpendicular to the rod and can cause leakage.

In these instances just mentioned, leakage is actually a by-product of other trouble; however, leakage can in itself be a problem. During break-in, where a discrepancy may exist between the rings and the rod due to expansion, blow-by can destroy the oil film and cause excessive packing temperatures, causing further expansion and blow-by. In this case, leakage is the problem in itself.

Packing Care During Assembly

One of the large contributing factors to the ultimate life of a metallic packing is the break-in. As has been discussed, break-in consists of wearing the rings to a suitable fit with the rod at operating temperature. The most expedient way to accomplish this is to run at the operating temperature. It is difficult to predict with any degree of accuracy the exact temperature of each pair of rings in the set or of the piston rod because of the variables which affect it; consequently, premachining to obtain the fit and operating conditions is in most cases impractical. Proper break-in can be broken down into the following steps: assembly, wear-in and burnishing.

Assembly requires care in handling of the parts to prevent damage, observing a few simple precautions and following the assembly drawing provided with the operator's manual. The parts should all be free of nicks, burrs, scratches, etc., and should be laid out in the order in which they are to be assembled.

As the rings are assembled on the rod, care should be taken that the numbered side faces the pressure, and that dirt or foreign material does not separate the joints of the rings or the rings of a pair. On lubricated packing, the rings should be liberally coated with oil.

The cup joints should also be free of anything which would hold them apart and interfere with their seal.

With the packing assembled and in the stuffing box, the flange studs should be tightened as any gasketed joint-applying pressure through opposite studs gradually to obtain even crushing of the gaskets. This

will prevent cocking of the packing cups and ensure their being in a perpendicular plane with the piston rod.

Before making oil connections to the packing, the lubricators should be hand operated to ensure that oil is reaching the point of the connection. After making the connections, the lubricator should continue to be hand operated to fill the oil holes in the case.

During break-in, some operators have found that filling the lubricator with a heavier oil than will be used during operation is helpful since the heavier, more viscous oil will help seal the rings during wear-in. Extra oil can be put on the rod with a swab or an oil can at the face of the flange.

Check the cooling system to ensure that it is functioning properly and that an unrestricted flow of coolant is obtained. Temperature control is a most important factor during break-in.

Wear-In of Metallic Rings

Wear-in begins with a no-load run for a short period to ensure that a film of lubricant has been created between the wearing parts. The load should be applied in increments, allowing a period of run-in at each pressure level. The length of time at each level will depend on the particular job. If the packing temperature continues to rise without stabilizing at any given pressure level, or if oil coming from the face of the packing is darkened, showing signs of excessively rapid wear, or if leakage occurs, the pressure should be dropped back to the previous level for additional running.

It should be kept in mind that generally the packing temperature is checked at the face of the flange, which is the most remote part of the packing from the point of highest generation of heat, so that in determining whether or not a stabilized temperature has been reached, allowance must be made for the fact that the heat must travel through the packing case to the packing flange where it is being felt. Burnishing of the rubbing surfaces begins when the packing rings have worn to a fit at the operating temperature. During this period, extra oil should continue to be fed to the packing for several hours after reaching operating conditions.

It is during the first few hours of operation at actual operating conditions that the rings achieve the burnished rubbing surface that contributes so greatly to their life.

Break-in practice of some operators is to lap the rings to the rod. In general, this is of little if any help. The bore of packing rings is, by comparison to their other surfaces, rough. This is an intentional finish and is so made to speed the wearing-in process. Lapping the surface will

generally leave a smooth finish which can inhibit break-in and it serves only to obtain a size which is not the actual size at operating temperature.

Break-in compounds have been used by some operators to speed “wearing out” of the ring to a fit on the rod. Unfortunately, they frequently leave a residue which can cause the rings to stick or bind in the grooves and are a problem more frequently than not.

Wear-In of Filled TFE Rings

One of the great advantages gained from the use of filled TFE packing rings has been the virtual elimination of the break-in or wear-in period. Because the material has some degree of conformability it is possible, even desirable, to obtain operating conditions on the packing as quickly as permitted by the process. If the TFE rings are being used in lubricated service and it is desired to operate with minimum lubrication, it is generally desirable that the packing be started with higher feed rates than ultimately intended and that the rate be gradually reduced to the desired level.

Conclusion

Mechanical packing is a precision seal accurately machined inside and out. It must be handled carefully, installed intelligently, and operated with good judgment. It is not a frail part to be installed in your machine; it is built as ruggedly as any finely finished, accurately machined piece of equipment can be, but a bump may burr or scratch it and disturb its seal. A chip or grain of dirt may hold the sealing surfaces apart, bind the rings tight in the groove, or cause premature wear.

Treat your Mechanical Packing with Respect, Break it in Carefully, Keep it Clean, Lubricate it Properly and it Will Serve You Economically, Faithfully and Well.

Venting and Purging of Packing

During normal dynamic operation of compressor packing, a certain amount of process gas leakage will occur through the packing ring set, and this can vary according to various operating parameters including gas molecular weight, piston rod diameter, whether lubricated or oil-free, etc.

To prevent process gas emissions to atmosphere (or crankcase) it is necessary to divert any gas leakage, through a gas vent line piped to a safe area. This vent line is taken from within the packing assembly, prior to the final packing ring seal, and via a pipe connected onto the packing flange.

For total control of the process gas with a guarantee of no emissions to atmosphere it is necessary to supply a purge (or buffer) gas — usually inert

nitrogen — to the packing assembly in addition to special side loaded packing rings. To be effective, this must be supplied at a pressure higher than the vent line pressure, and to a position between the vent and the final packing ring seal.

Purge control panels are available which provide automatic control of purge gas supply and ensure that the proper differential pressure relative to vent pressure is maintained.

Static Sealing

Some users wish to hold pressurized gas inside the compressor cylinder while the compressor is stopped. This cannot be successfully achieved with conventional compressor packings, which are designed to function dynamically. For such requirements, it is necessary to incorporate a static sealing device within the packing assembly. This sealing device is pneumatically activated whenever the compressor is stopped, and de-activated when the compressor re-starts



Proven Solutions for the Global Compression Industry™

© 2015 CPI. All rights reserved.